

Fuse block w/ 4P , with LED warning light

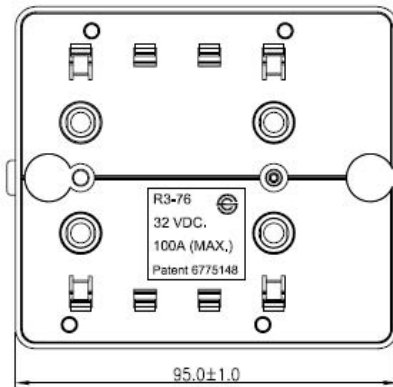

Unit: mm

Voltage (Max.)	32 VDC.	Mounting Hole	
Input Terminal Rating	#10-32 threaded studs (100A. max.)		
Output Terminal Rating	30A max per circuit.		
Connection pad option available	Input wire size : #4-6 AWG. Output wire size : #12-16 AWG	Terminal Dim.	Blade Fuse Dim.
Fuse Spec.	For Blade Fuses Used Only		
Torque Rating	20in-lb (2.25Nm) max.	Circuit Diagram	
Mounting Torque Rating	8in-lb (0.9Nm) max.		
Temperature Rating	-20° C to 85° C		

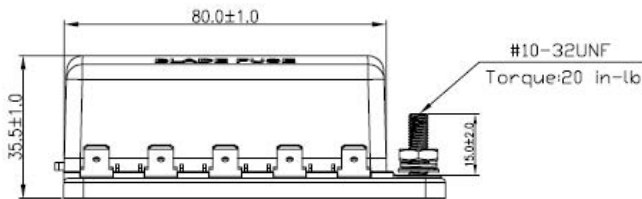
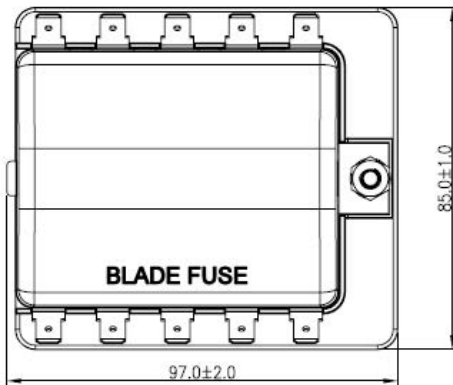
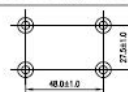
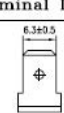
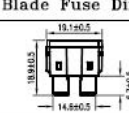
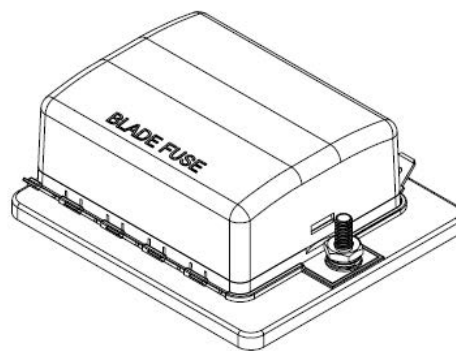
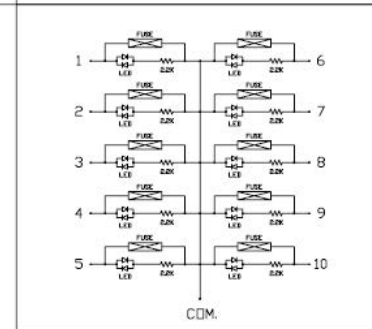
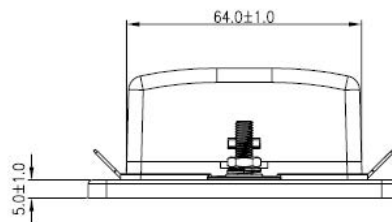

Material :
 Cover : PC. (Transparent)
 Housing , Base : PBT. (Black)
 Push Button : POM. (White)
 Terminal : Tin. plating Copper

Notes :
 1. Rating 100A max. tested by
 4 pcs. 25A load.